

6MBP75TEA120

Econo IPM series

1200V / 75A 6 in one-package

■ Features

- Temperature protection provided by directly detecting the junction temperature of the IGBTs
- Low power loss and soft switching
- High performance and high reliability IGBT with overheating protection
- Higher reliability because of a big decrease in number of parts in built-in control circuit



■ Maximum ratings and characteristics

- Absolute maximum ratings(at Tc=25°C unless otherwise specified)

Item		Symbol	Rating		Unit	
			Min.	Max.		
Bus voltage	DC	V _{DC}	0	900	V	
	Surge	V _{DC(surge)}	0	1000	V	
	Short operating	V _{SC}	400	800	V	
Collector-Emitter voltage *1		V _{CES}	0	1200	V	
Inverter	Collector current	DC	I _C	-	75	A
		1ms	I _{CP}	-	150	A
		DC	-I _C	-	75	A
	Collector power dissipation	One transistor *3	P _C	-	368	W
Supply voltage of Pre-Driver *4		V _{CC}	-0.5	20	V	
Input signal voltage *5		V _{in}	-0.5	V _{CC} +0.5	V	
Input signal current		I _{in}	-	3	mA	
Alarm signal voltage *6		V _{ALM}	-0.5	V _{CC}	V	
Alarm signal current *7		I _{ALM}	-	20	mA	
Junction temperature		T _j	-	150	°C	
Operating case temperature		T _{opr}	-20	100	°C	
Storage temperature		T _{stg}	-40	125	°C	
Solder temperature *8		T _{sol}	-	260	°C	
Isolating voltage (Terminal to base, 50/60Hz sine wave 1min.)		V _{iso}	-	AC2500	V	
Screw torque	Mounting (M5)		-	3.5	N·m	

Note

*1 : V_{CES} shall be applied to the input voltage between terminal P and U or ,V or W, N and U or V or W

*2 : $125^{\circ}\text{C}/\text{FWD } R_{\text{th(j-c)}}/(I_{\text{c}} \times V_{\text{F MAX}}) = 125/0.61/(75 \times 2.0) \times 100 > 100\%$

*3 : $P_{\text{c}} = 125^{\circ}\text{C}/\text{IGBT } R_{\text{th(j-c)}} = 125/0.34 = 368\text{W}$ [Inverter]

*4 : V_{CC} shall be applied to the input voltage between terminal No.4 and 1, 8 and 5, 12 and 9, 14 and 13

*5 : V_{in} shall be applied to the input voltage between terminal No.3 and 1, 7 and 5, 11 and 9, 16,17,18 and 13.

*6 : V_{ALM} shall be applied to the voltage between terminal No.2 and 1, No6 and 5, No10 and 9, No.19 and 13.

*7 : I_{ALM} shall be applied to the input current to terminal No.2,6,10 and 19.

*8 : Immersion time 10±1sec.

● **Electrical characteristics** (at $T_c=T_j=25^\circ\text{C}$, $V_{cc}=15\text{V}$ unless otherwise specified.)

Main circuit

Item		Symbol	Condition	Min.	Typ.	Max.	Unit	
Inverter	Collector current at off signal input	I_{CES}	$V_{CE}=1200\text{V}$ V_{in} terminal open.	-	-	1.0	mA	
	Collector-Emitter saturation voltage	$V_{CE(sat)}$	$I_c=75\text{A}$	Terminal	-	-	3.1	V
				Chip	-	2.2	-	
	Forward voltage of FWD	V_F	$-I_c=75\text{A}$	Terminal	-	-	2.0	V
Chip				-	1.6	-		
Turn-on time		t_{on}	$V_{DC}=600\text{V}, T_j=125^\circ\text{C}$	1.2	-	-	μs	
Turn-off time		t_{off}	$I_c=75\text{A}$ Fig.1, Fig.6	-	-	3.6		
Reverse recovery time		t_{rr}	$V_{DC}=600\text{V}, I_F=75\text{A}$ Fig.1, Fig.6	-	-	0.3		

● **Control circuit**

Item	Symbol	Condition	Min.	Typ.	Max.	Unit
Supply current of P-line side pre-driver(one unit)	I_{ccp}	Switching Frequency : 0 to 15kHz $T_c=-20$ to 125°C Fig.7	-	-	15	mA
Supply current of N-line side pre-driver	I_{ccn}		-	-	45	mA
Input signal threshold voltage (on/off)	$V_{in(th)}$	ON	1.00	1.35	1.70	V
		OFF	1.25	1.60	1.95	V
Input zener voltage	V_Z	$R_{in}=20\text{k ohm}$	-	8.0	-	V
Alarm signal hold time	t_{ALM}	$T_c=-20^\circ\text{C}$ Fig.2	1.1	-	-	ms
		$T_c=25^\circ\text{C}$ Fig.2	-	2.0	-	ms
		$T_c=125^\circ\text{C}$ Fig.2	-	-	4.0	ms
Current limit resistor	R_{ALM}	Alarm terminal	1425	1500	1575	ohm

● **Protection Section** ($V_{cc}=15\text{V}$)

Item	Symbol	Condition	Min.	Typ.	Max.	Unit
Over Current Protection Level of Inverter circuit	I_{oc}	$T_j=125^\circ\text{C}$				A
Over Current Protection Delay time	t_{DOC}	$T_j=125^\circ\text{C}$	113	-	-	μs
SC Protection Delay time	t_{SC}	$T_j=125^\circ\text{C}$ Fig.4	-	5	-	μs
IGBT Chip Over Heating Protection Temperature Level	T_{jOH}	Surface of IGBT chips	-	-	8	$^\circ\text{C}$
Over Heating Protection Hysteresis	T_{jH}		150	-	-	V
Under Voltage Protection Level	V_{UV}		-	20	-	V
Under Voltage Protection Hysteresis	V_H		11.0	-	12.5	
			0.2	0.5	-	

● **Thermal characteristics**($T_c=25^\circ\text{C}$)

Item			Symbol	Min.	Typ.	Max.	Unit
Junction to Case thermal resistance *9	Inverter	IGBT	$R_{th(j-c)}$	-	-	0.34	$^\circ\text{C/W}$
		FWD	$R_{th(j-c)}$	-	-	0.61	$^\circ\text{C/W}$
Case to fin thermal resistance with compound			$R_{th(c-f)}$	-	0.05	-	$^\circ\text{C/W}$

*9 : (For 1 device, Case is under the device)

● **Noise Immunity** ($V_{DC}=300\text{V}$, $V_{cc}=15\text{V}$, Test Circuit Fig.5)

Item	Condition	Min.	Typ.	Max.	Unit
Common mode rectangular noise	Pulse width $1\mu\text{s}$, polarity \pm , 10minuets Judge : no over-current, no miss operating	± 2.0	-	-	kV
Common mode lightning surge	Rise time $1.2\mu\text{s}$, Fall time $50\mu\text{s}$ Interval 20s, 10 times Judge : no over-current, no miss operating	± 5.0	-	-	kV

● **Recommendable value**

Item	Symbol	Min.	Typ.	Max.	Unit
DC Bus Voltage	V_{DC}	-	-	800	V
Operating Supply Voltage of Pre-Driver	V_{cc}	13.5	15.0	16.5	V
Screw torque (M5)	-	2.5	-	3.0	Nm

● **Weight**

Item	Symbol	Min.	Typ.	Max.	Unit
Weight	W_t	-	270	-	g

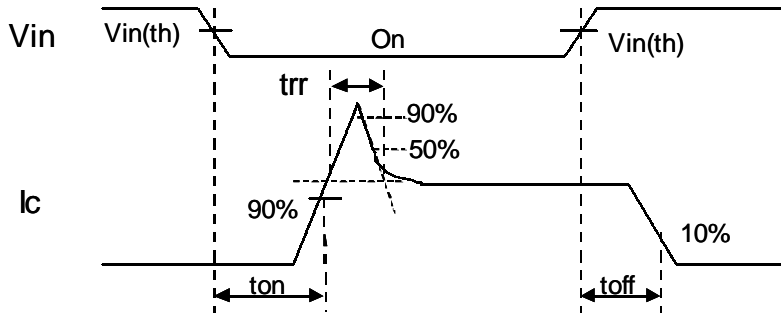
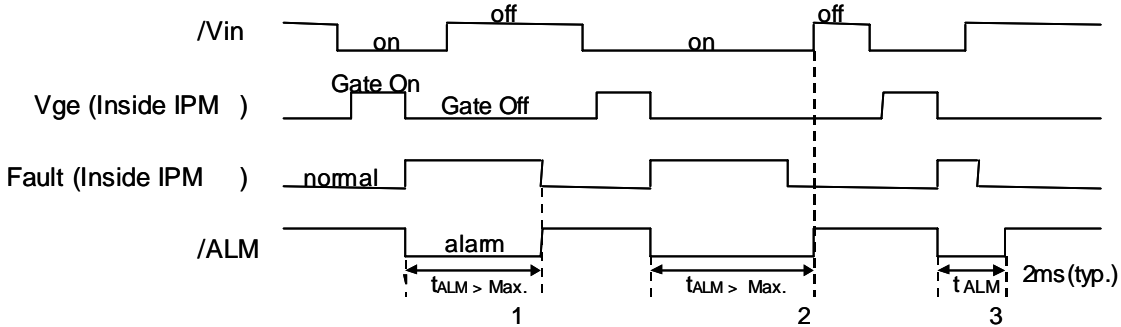

Figure 1. Switching Time Waveform Definitions



Fault : Over-current, Over-heat or Under-voltage

Figure 2. Input/Output Timing Diagram

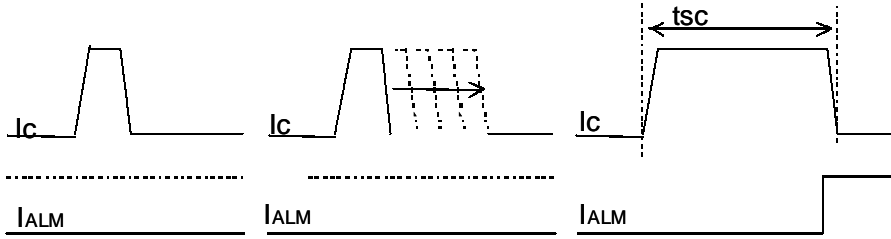

Figure.4 Definition of tsc

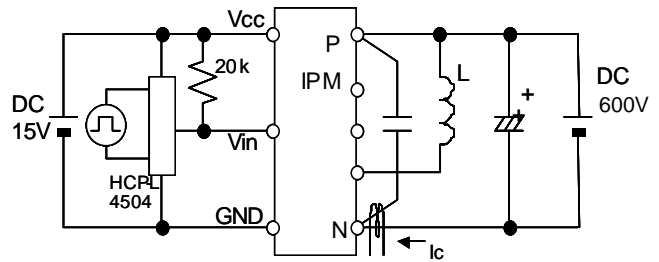

Figure 6. Switching Characteristics Test Circuit

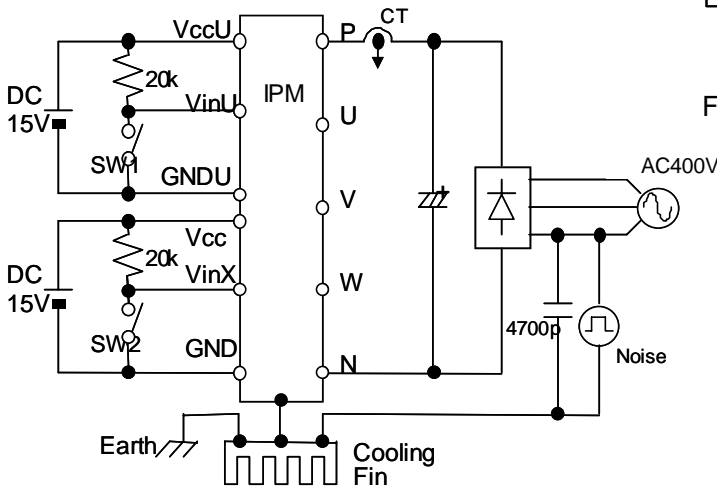

Figure 5. Noise Test Circuit

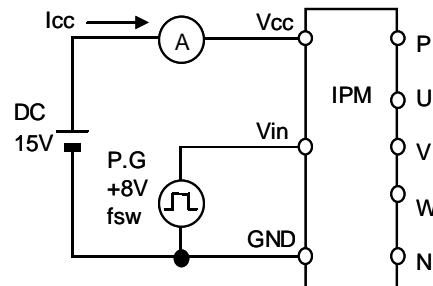
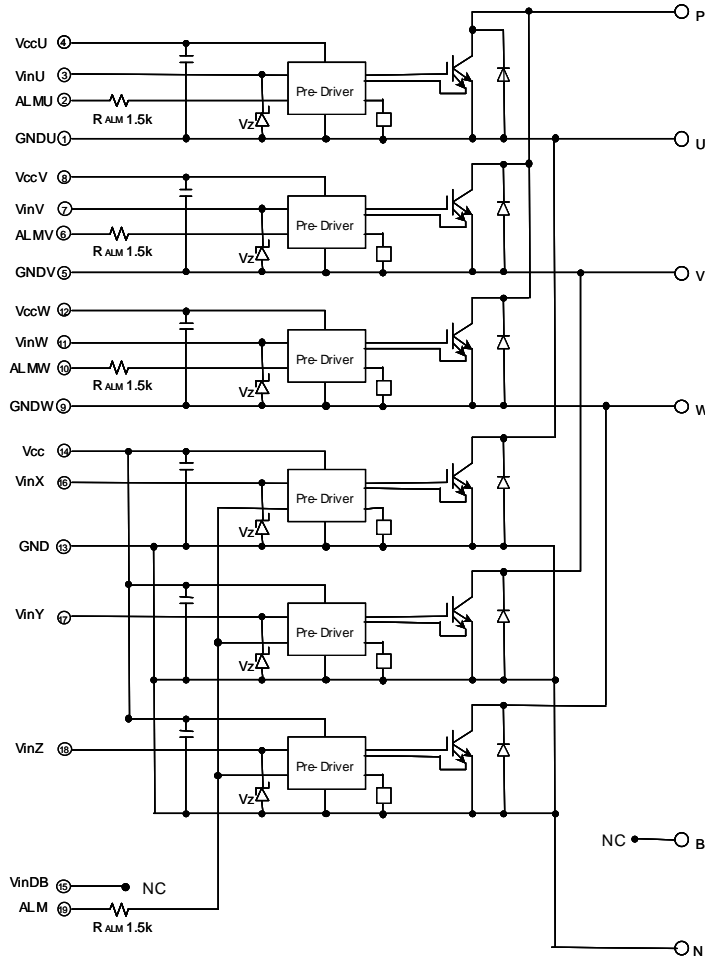

Figure 7. Icc Test Circuit

Block diagram



Pre-drivers include following functions

1. Amplifier for driver
2. Short circuit protection
3. Under voltage lockout circuit
4. Over current protection
5. IGBT chip over heating protection

Outline drawings, mm

Package type : P622
Dimensions in mm

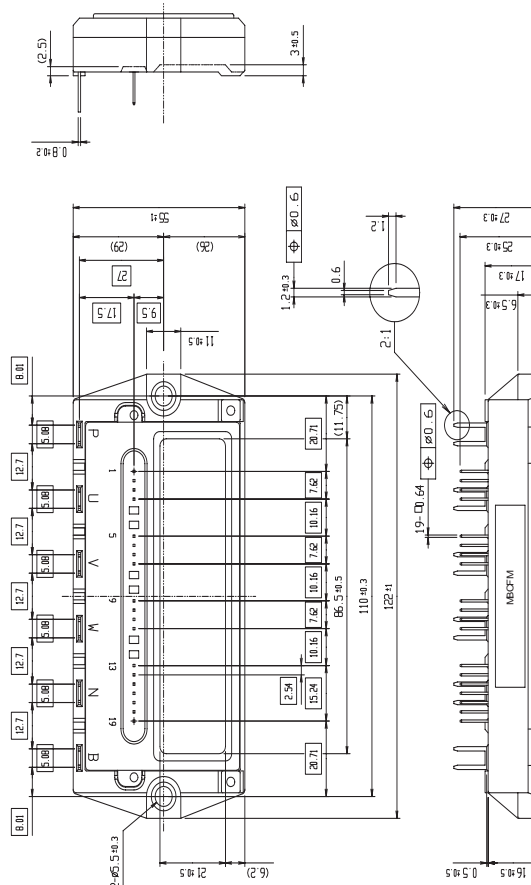

Mass : 270g

Characteristics

Control circuit characteristics (Representative)

Power supply current vs. Switching frequency
Tc=125°C (typ.)

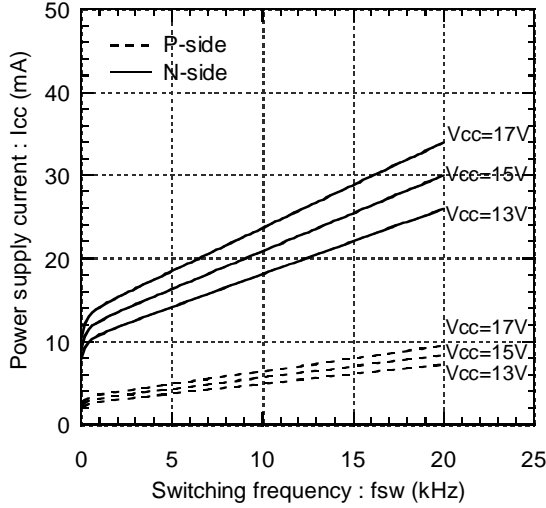

Input signal threshold voltage vs. Power supply voltage (typ.)
Tj=25°C (solid line), Tj=125°C (dashed line)

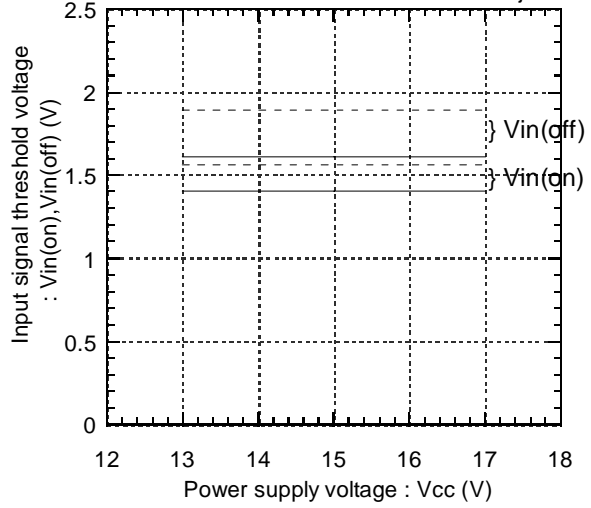

Under voltage vs. Junction temperature (typ.)

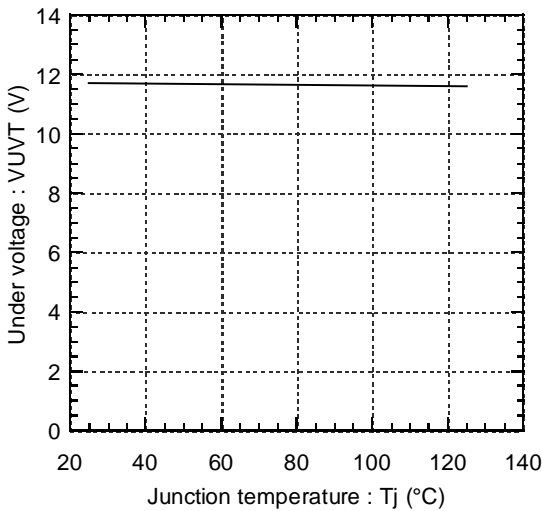

Under voltage hysteresis vs. Junction temperature (typ.)

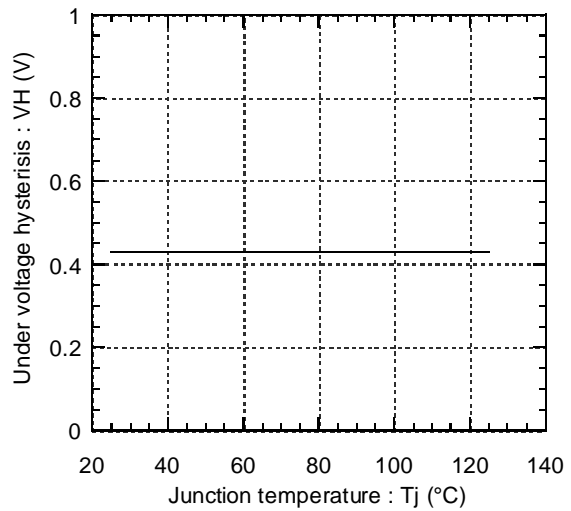

Alarm hold time vs. Power supply voltage (typ.)

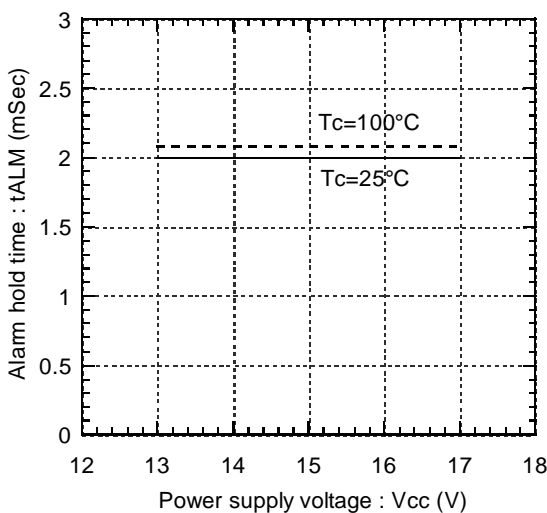

Over heating characteristics
TjOH, TjH vs. Vcc (typ.)

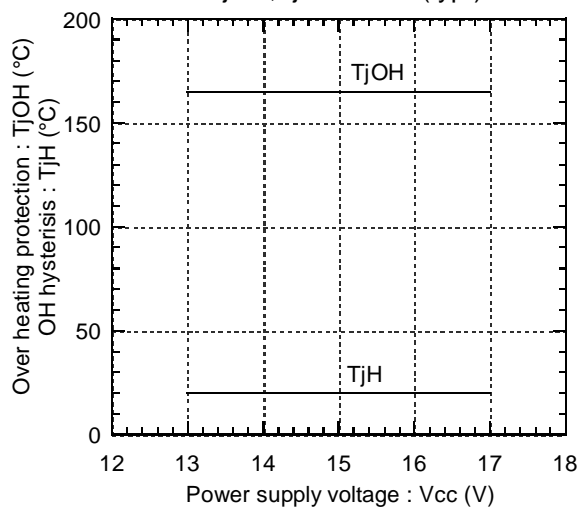

● Main circuit characteristics (Representative)

Collector current vs. Collector-Emitter voltage (typ.)
Tj=25°C(Chip)

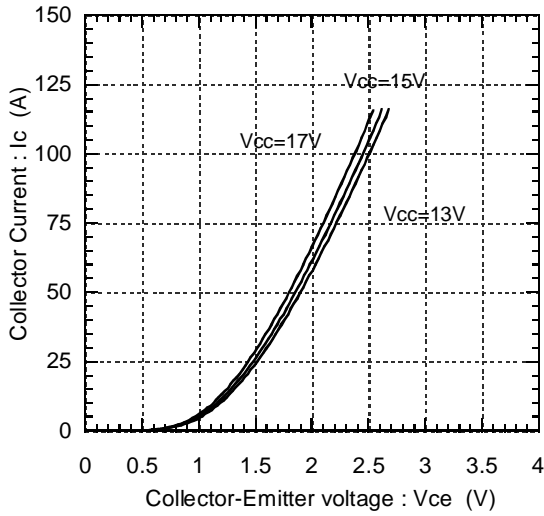

Collector current vs. Collector-Emitter voltage (typ.)
Tj=25°C(Terminal)

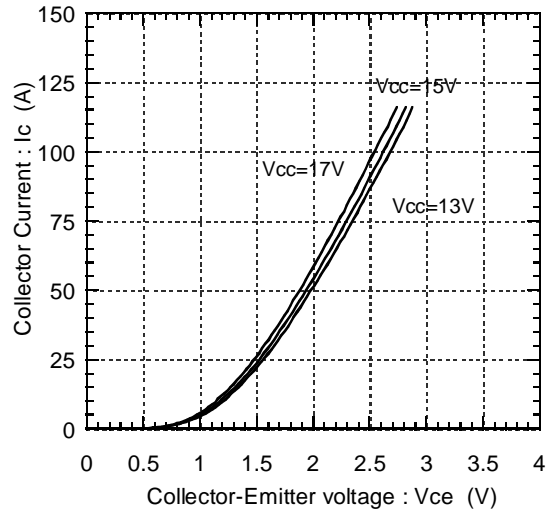

Collector current vs. Collector-Emitter voltage (typ.)
Tj=125°C(Chip)

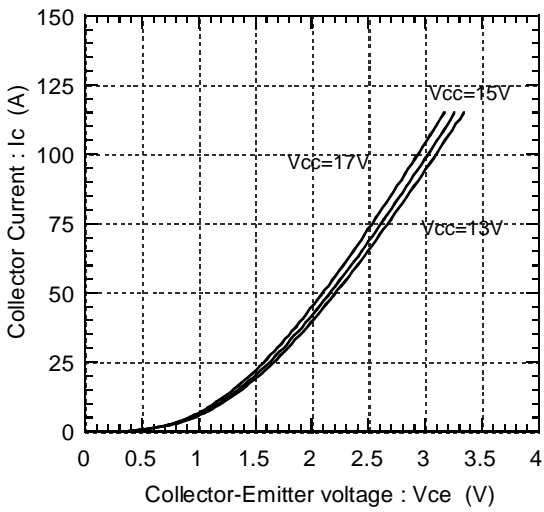

Collector current vs. Collector-Emitter voltage (typ.)
Tj=125°C(Terminal)

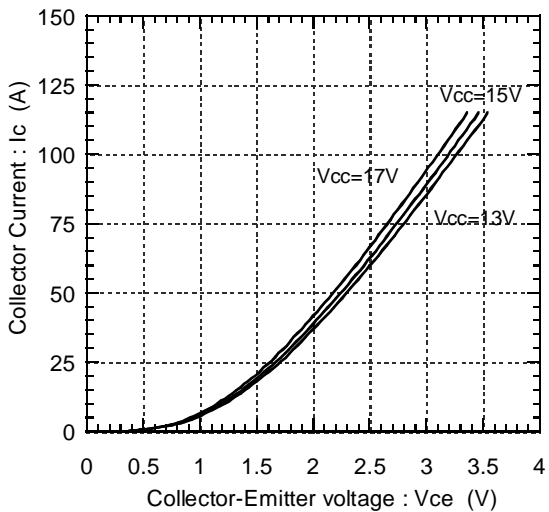

Forward current vs. Forward voltage (typ.)
(Chip)

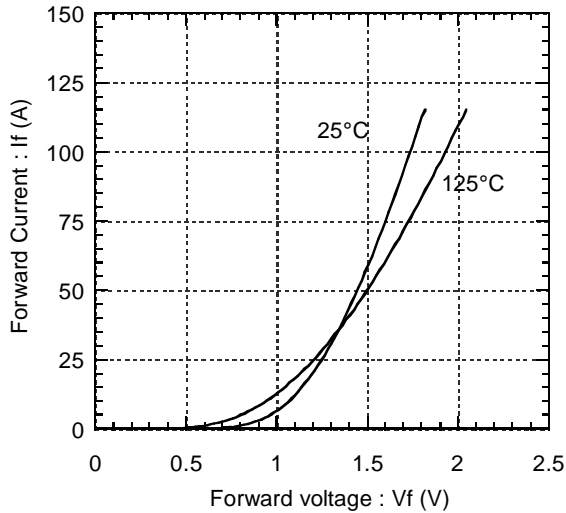

Forward current vs. Forward voltage (typ.)
(Terminal)

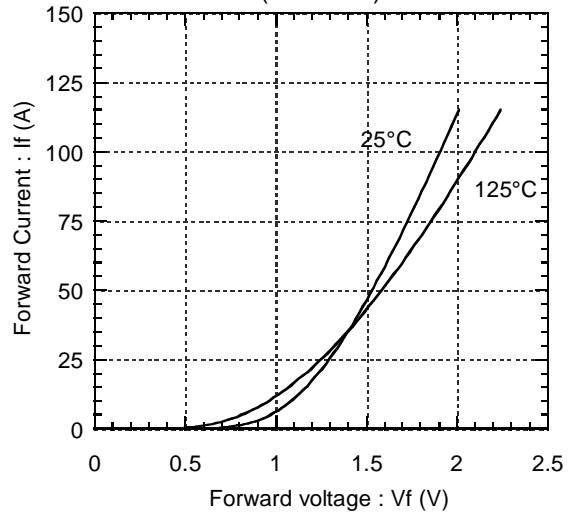

Switching Loss vs. Collector Current (typ.)
 $E_{dc}=600V, V_{cc}=15V, T_j=25^\circ C$

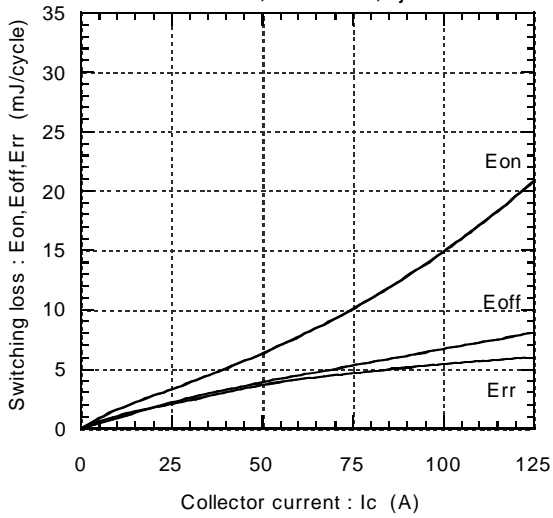

Switching Loss vs. Collector Current (typ.)
 $E_{dc}=600V, V_{cc}=15V, T_j=125^\circ C$

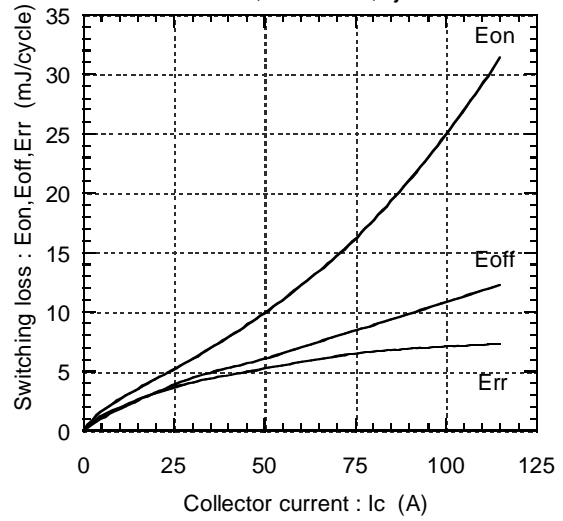

Reversed biased safe operating area
 $V_{cc}=15V, T_j \le 125^\circ C$ (min.)

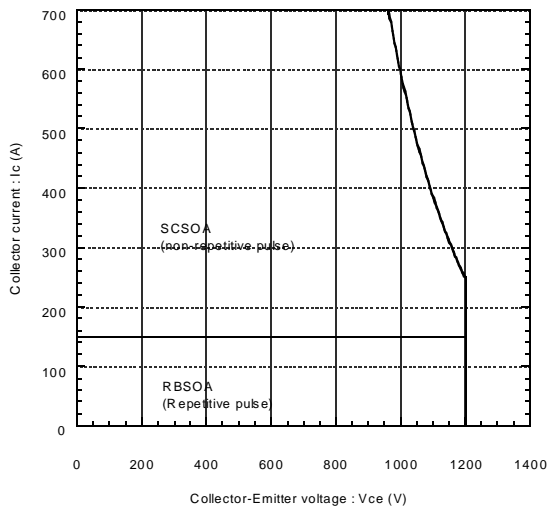

Transient thermal resistance (max.)

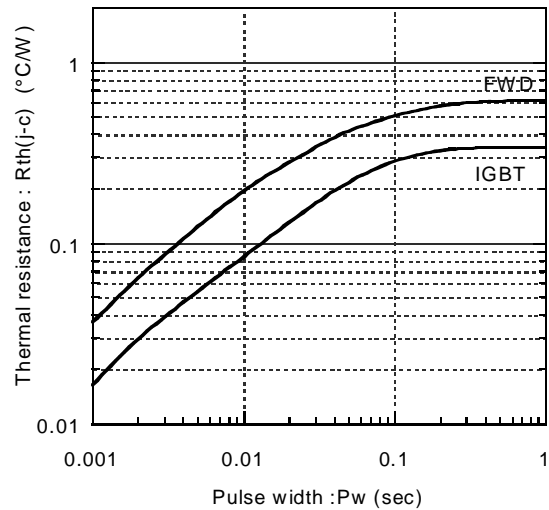

Power derating for IGBT (max.)
 (per device)

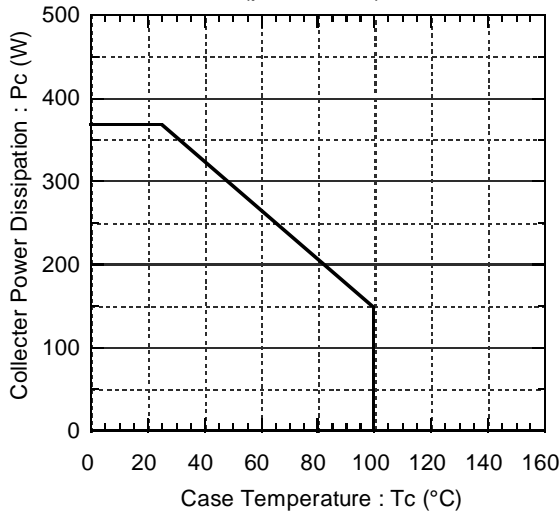

Power derating for FWD (max.)
 (per device)

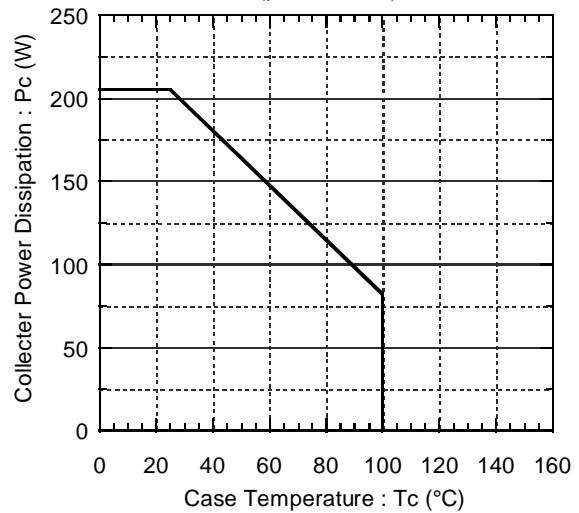

Switching time vs. Collector current (typ.)
 E_{dc}=600V, V_{cc}=15V, T_j=25°C

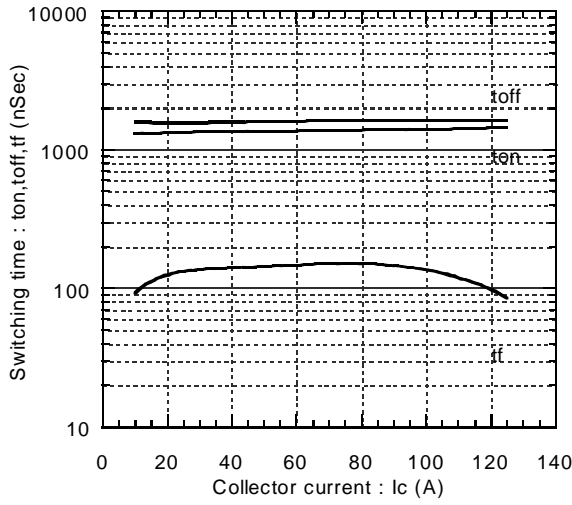

Switching time vs. Collector current (typ.)
 E_{dc}=600V, V_{cc}=15V, T_j=125°C

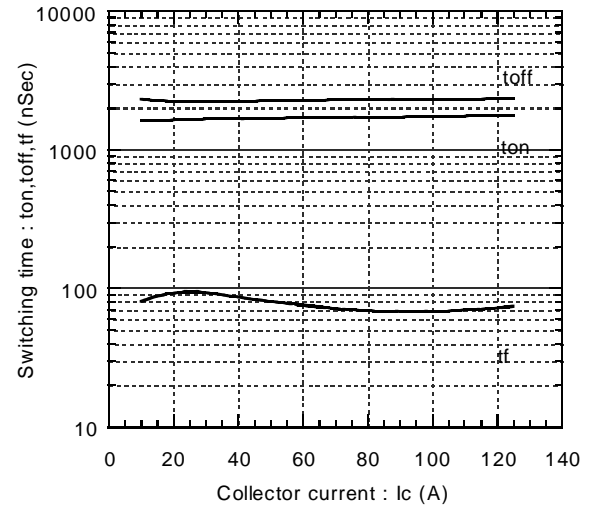

Reverse recovery characteristics (typ.)
 t_{rr}, I_{rr} vs. I_F

